

## Quick-Install Engineered Ball Screw Assemblies

### Get the 'just-right' fit

- Step by step selection assistance based on application parameters
- New configurations available
  - MK Supports - NEMA motor supports (Size 23 and 34)
  - WK Supports - Heavy duty supports for demanding applications

### Speed and simplify installation

- Pre-engineered assemblies to meet your system requirements
- Integrated ball screw and supports with motor ready mounting option

### Drop in replacements, fast delivery

- Popular ball screw assemblies and accessories available fast for replacement installations
- Additional configurations and sizes available upon request
- Industry-leading delivery times on all ball screw assemblies

**THOMSON**<sup>®</sup>

*Linear Motion. Optimized.<sup>™</sup>*

## Configured Ball Screw Assembly Advantages

### Why get this?



### Traditional process:

1. Size and select ball screw
2. Place order
3. Receive and inspect
4. Cut ball screw to length
5. Anneal ball screw ends
6. Straighten ball screw
7. Machine centers onto ball screw
8. Rough turn end journals
9. Finish grind end journals
10. Polish end journals
11. Degrease and clean ball screw
12. Straighten ball screw
13. Assemble, time, and pin optional flange to ball nut
14. Install optional wipers
15. Transfer ball nut onto screw
16. Mount end supports
17. Lubricate ball nut
18. Install system

### When you can have this!

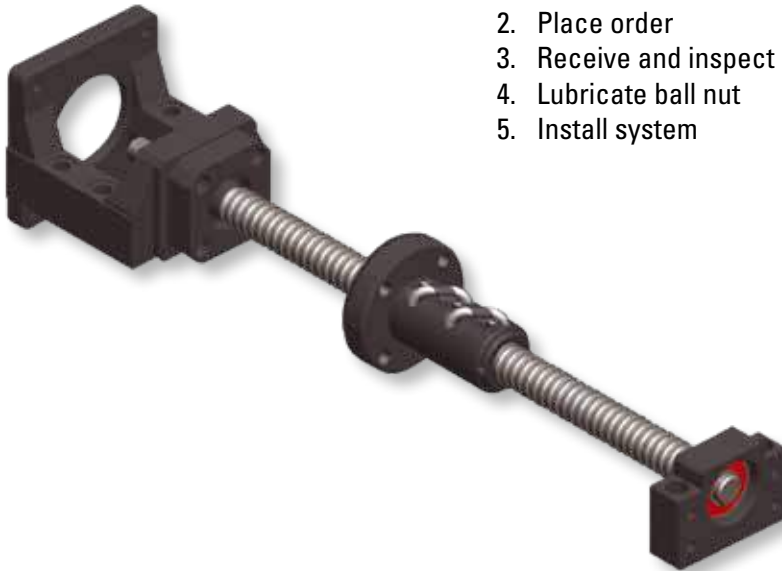

### Thomson Quick-Install process:

1. Size and select assembly
2. Place order
3. Receive and inspect
4. Lubricate ball nut
5. Install system

### Assembly and installation is critical to ball screw performance:

*Save time and money while improving quality.*

*Reduce order / installation time by up to 90%.*

*Save up to 50% of total assembly cost.*

## How to select a configured ball screw assembly:

Identify the minimum required parameters and answer a couple basic questions:

- a. Load – Amount of force that will be applied axially to a ball screw
- b. Speed – RPM or linear travel rate
- c. Mounting requirement – base or flange mount
- d. Life requirement
- e. Inch or metric?
- f. Is backlash acceptable?

## Here is an example to demonstrate the ease and simplicity of the process:

For these given values:

- a. Load = 1,500 lbs
- b. Speed = 500 in/min and 1,200 RPM maximum
- c. Mounting = Flange supports required
- d. Life = 1 million inches of travel
- e. Travel length = 48 inches
- f. Lash = Backlash is acceptable

### Step 1 – Select ball screw diameter based on load capacity and mounting configuration

Go to Table 1 and select the FK-FK column and find the cell that exceeds the load requirement. In this example, a Ø1.000 screw has a rating of 1,875 lbs and is acceptable.

### Step 2 – Select lead and ball nut p/n

Since lead = linear rate / RPM, the lead is 500 in/min / 1200 rotations/min = .417 inches / rotation. Select a lead from Table 2 that is greater than the calculated amount. In this example, select .500 lead which equates to 500 / .500 = 1,000 RPM. Since backlash is acceptable in this application, choose a 1.000 x .500 standard ball nut (p/n 8110-448-022).

### Step 3 – Verify life requirement of ball nut and end support.

Use Table 3 to find dynamic capacity rating of the ball nut ( $C_{am} = 3,950$  lbs) and the end support selection ( $C_{am} = 2,270$  lbs).

Calculate the life of the ball screw assembly using standard  $L_{10}$  life equation.

$$L_{10} = (C_{am}/Load)^3, L_{10} = (3,950/1,500)^3 = 18.3 \text{ million inches of travel} = 36.6 \text{ million revolutions.}$$

Calculate the life of the end supports using standard  $L_{10}$  life equation.

$$L_{10} = (C_{am}/Load)^3, L_{10} = (2,270/(1,500/2))^3 = 27.7 \text{ revolutions.}$$

### Step 4 – Verify screw meets critical speed limitation

Use critical speed graph for FK-FK support and verify that assembly is below the critical speed curve. Use calculated RPM (1,000) and travel length (48in) and verify that the intersect point is below and to the left of the Ø1.000 curve.

### Step 5 – Build configured part number

The configured part number for this example is therefore: 1000x0500S 48.000 FK-FK SSFW

### Step 6 – Contact Thomson Customer Support (Call 540-633-3549) or [thomson@thomsonlinear.com](mailto:thomson@thomsonlinear.com) or your local Thomson Distributor to order

## How to Select an Inch Series Ball Screw Assembly

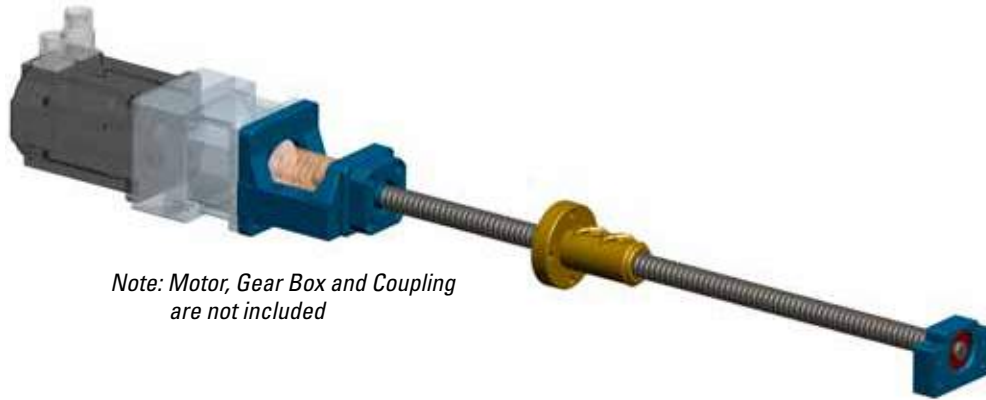







Note: Motor, Gear Box and Coupling are not included

### Step 1 - Select ball screw diameter based on load capacity and mounting configuration

- Table below indicates maximum axial load that selected ball nut diameter and end configuration can support
- Select a ball screw diameter / end support configuration with a load capacity exceeding application requirement



**Table 1 - End Support Axial Load Capacity**

Ball Screw Dia.	 BK - BK	 BK - BF	 FK - FK	 FK - FF	 MK - BK	 MK - BF	 WK - WK
0.500 in	600 lb	300 lb	600 lb	300 lb	600 lb	300 lb	-
0.631 in	675 lb	338 lb	675 lb	338 lb	675 lb	338 lb	-
0.750 in	775 lb	388 lb	775 lb	388 lb	775 lb	388 lb	-
0.875 in	1,350 lb	675 lb	1,350 lb	675 lb	-	-	11,950 lb
1.000 in	1,475 lb	738 lb	1,875 lb	938 lb	1,675 lb	938 lb	11,950 lb
1.150 in	2,325 lb	1,163 lb	2,325 lb	1,163 lb	-	-	18,300 lb
1.500 in	3,325 lb	1,663 lb	3,325 lb	1,663 lb	-	-	19,400 lb
2.000 in	6,650 lb	3,325 lb	-	-	-	-	23,370 lb

### Step 2 - Select lead

- Select preload if zero lash is required
- Select lead based on required speed
- Linear speed (in/min) = (RPM) x (Lead)





**Table 2 - Ball Nut Part Number**

Dia. x Lead	 Standard Nut Part Number	 Preload Nut Part Number	Maximum Screw Length (in)
.500 x .200	8105-448-013	8105-448-008	72.000
.500 x .500	8105-448-014	-	72.000
.631 x .200	8106-448-022	8106-448-012	144.000
.631 x 1.000	7826713	7827531	96.000
.750 x .200	8107-448-018	8107-448-025	144.000
.750 x .500	8107-448-014	8107-448-011	144.000
.875 x .200	5708277	-	144.000
1.000 x .250	8110-448-055	7824167	288 / 240
1.000 x .500	8110-448-022	8110-448-016	288.000
1.000 x 1.000	8110-448-086	-	288.000
1.150 x .200	8111-448-006	8111-448-004	288.000
1.500 x .250	7833233	7833234	240.000
1.500 x .473	5707513	-	240.000
1.500 x .500	8115-448-016	8115-448-006	288.000
1.500 x 1.000	5708280	5700698	240.000
1.500 x 1.875	5707654	5704272	240.000
1.500 x 2.000	8115-448-056	-	288.000
2.000 x .500	8120-448-011	8120-448-006	288.000
2.000 x 1.000	8120-448-021	8120-448-019	288.000

### Step 3 - Verify life requirement of ball nut and end support

- Calculate life of ball screw assembly using  $L_{10} = (C_{am} / \text{Load})^3$  million inches
  - Calculate life of end supports using  $L_{10} = (C_{am} / \text{Load per support})^3$  million revolutions
- i.e. : Divide load by 2 if using 2 BK-BK, FK-FK, MK-BK, or WK-WK.*

**Table 3 - Component Dynamic Capacity**

Dia. x Lead	 Standard Nut $C_{am}$ (lb)	 Preload Nut $C_{am}$ (lb)	 BK Support $C_{am}$ (lb)	 FK / MK Support $C_{am}$ (lb)	 WK Support $C_{am}$ (lb)
.500 x .200	1,200	1,200	430	430	-
.500 x .500	929	-	430	430	-
.631 x .200	800	800	478	478	-
.631 x 1.000	578	578	478	478	-
.750 x .200	950	950	529	529	-
.750 x .500	3,450	3,450	529	529	-
.875 x .200	1,942	-	910	910	5,980
1.000 x .250	1,612	1,612	1,656	2,270	5,980
1.000 x .500	3,950	3,950	1,656	2,270	5,980
1.000 x 1.000	2,400	-	1,656	2,270	5,980
1.150 x .200	2,400	2,400	2,742	2,742	9,105
1.500 x .250	4,198	4,198	3,632	3,632	9,667
1.500 x .473	10,050	-	3,632	3,632	9,667
1.500 x .500	14,513	14,513	3,632	3,632	9,667
1.500 x 1.000	8,250	8,250	3,632	3,632	9,667
1.500 x 1.875	7,242	7,242	3,632	3,632	9,667
1.500 x 2.000	7,600	-	3,632	3,632	9,667
2.000 x .500	18,500	18,500	7,093	-	11,691
2.000 x 1.000	21,200	21,200	7,093	-	11,691

**Step 4 - Verify screw meets critical speed limitation**

- Acceptable length / speed combinations are below and left of the selected curve (screw diameter)

**Figure 1 - Critical Speed Graph**

**Speed vs Length (Inch Series)  
BK -BF, FK-FF, MK-BF**

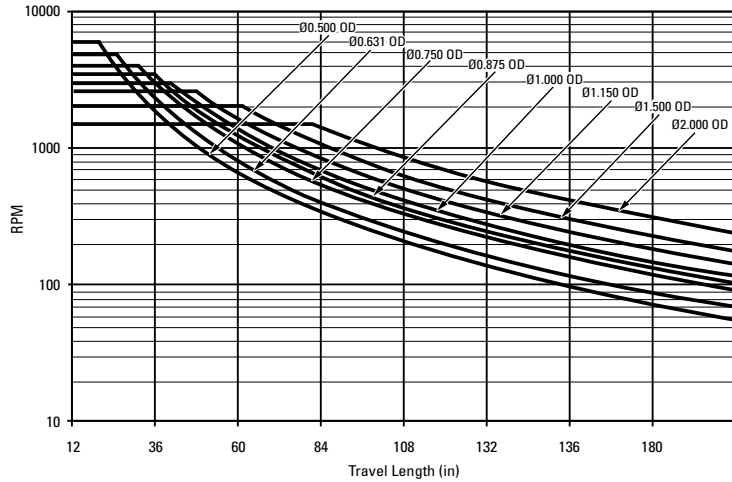

**Speed vs Length (Inch Series)  
BK-BK, FK-FK, MK-BK, WK-WK**

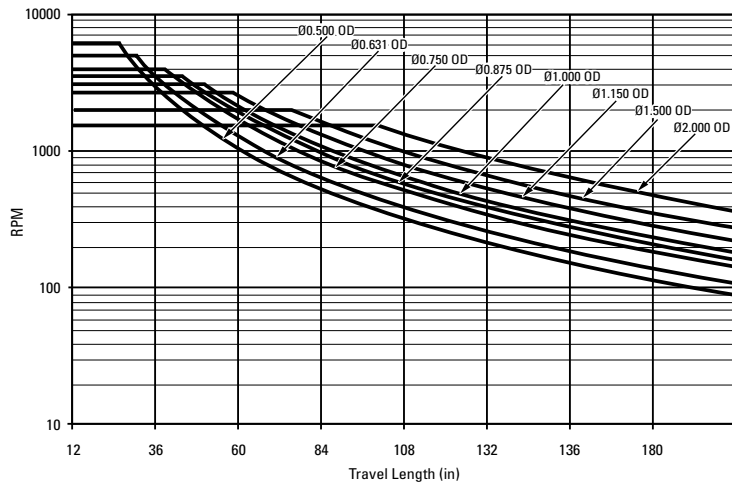

**Step 5 - Build Quick-Install Engineered Ball Screw Part Number - Inch Series Example**

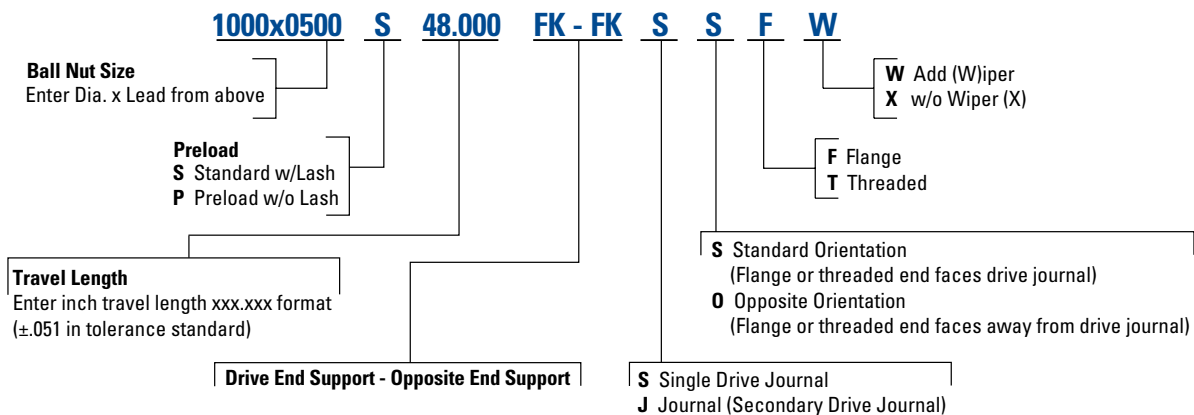

**Step 6 - Contact Thomson Customer Support (Call 540-633-3549) or thomson@thomsonlinear.com or your local Thomson Distributor to order**

# How to Select an Metric Series Ball Screw Assembly

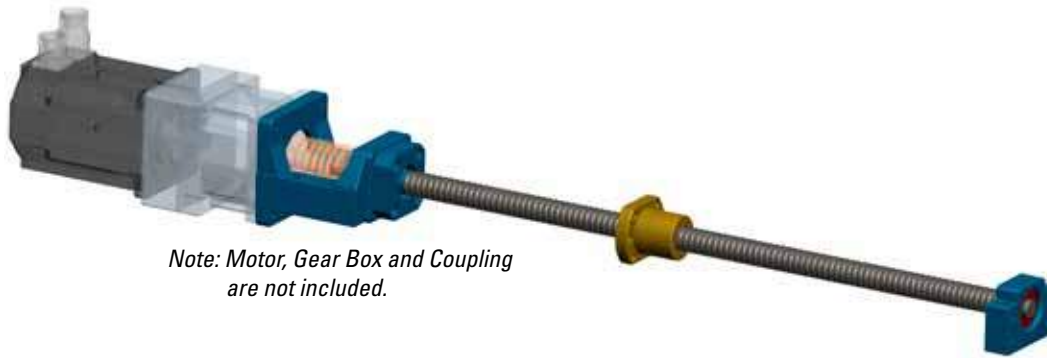





Note: Motor, Gear Box and Coupling are not included.

## Step 1 - Select system based on load capacity and mounting configuration

- Table below indicates maximum axial load that selected ball nut diameter and end configuration can support
- Select a ball screw diameter / end support configuration with a load capacity exceeding application requirement





**Table 1 - End Support Axial Load Capacity**

Ball Screw Dia.	 BK - BK	 BK - BF	 FK - FK	 FK - FF	 MK - BK	 MK - BF	 WK - WK
12mm	2,600 N	1,300 N	2,600 N	1,300 N	2,600 N	1,300 N	-
16mm	3,000 N	1,500 N	3,000 N	1,500 N	3,000 N	1,500 N	-
20mm	3,450 N	1,725 N	3,450 N	1,725 N	3,450 N	1,725 N	-
25mm	6,575 N	3,288 N	8,300 N	4,150 N	7,438 N	4,150 N	26,600 N
32mm	10,300 N	5,150 N	10,300 N	5,150 N	-	-	26,600 N
40mm	14,800 N	7,400 N	14,800 N	7,400 N	-	-	40,500 N
50mm	29,500 N	14,750 N	-	-	-	-	52,000 N

## Step 2 - Select lead

- Select preload if zero lash is required
- Select lead based on required speed
- Linear speed (in/min) = (RPM) x (Lead)







**Table 2 - Ball Nut Part Number**

 Dia. x Lead	 Flanged Nut Part Number	 Cylindrical Nut Part Number	 Threaded Nut Part Number	Maximum Screw Length (mm)
12 x 5	-	KGM-N-1205-RH-00	-	1,500
16 x 5	KGF-D-1605-RH-EE	KGM-D-1605-RH-EE	7832778	6,000
16 x 10	KGF-D-1610-RH-EE	KGM-D-1610-RH-EE	-	6,000
20 x 5	KGF-D-2005-RH-EE	KGM-D-2005-RH-EE	7832781	6,000
25 x 5	KGF-D-2505-RH-EE	KGM-D-2505-RH-EE	7832788	6,000
25 x 10	KGF-D-2510-RH-EE	KGM-D-2510-RH-EE	7832792	6,000
25 x 20	KGF-D-2520-RH-EE	KGM-D-2520-RH-EE	-	6,000
25 x 25	KGF-D-2525-RH-EE	KGM-D-2525-RH-EE	-	6,000
25 x 50	KGF-D-2550-RH-EE	KGM-D-2550-RH-EE	-	6,000
32 x 5	KGF-D-3205-RH-EE	KGM-D-3205-RH-EE	7832797	6,000
32 x 10	KGF-D-3210-RH-EE	KGM-D-3210-RH-EE	-	6,000
32 x 20	KGF-D-3220-RH-EE	KGM-D-3220-RH-EE	-	6,000
32 x 32	KGF-D-3232-RH-EE	-	-	6,000
32 X 40	KGF-N-3240-RH-EE	KGM-N-3240-RH-EE	-	6,000
40 x 5	KGF-D-4005-RH-EE	KGM-D-4005-RH-EE	7832806	6,000
40 x 10	KGF-D-4010-RH-EE	KGM-D-4010-RH-EE	7832810	6,000
40 x 20	KGF-D-4020-RH-EE	KGM-D-4020-RH-EE	-	6,000
40 x 40	KGF-D-4040-RH-EE	KGM-D-4040-RH-EE	-	6,000
50 x 10	KGF-D-5010-RH-EE	KGM-N-5010-RH-EE	7832819	6,000
50 x 20	KGF-D-5020-RH-EE	KGM-N-5020-RH-EE	-	6,000

## Step 3 - Verify life requirement of ball nut and end support

- Calculate life of ball screw assembly using  $L_{10} = (C_{am} / \text{Load})^3$  million revolutions
  - Calculate life of end supports using  $L_{10} = (C_{am} / \text{Load per support})^3$  million revolutions
- i.e. : Divide load by 2 if using 2 BK-BK, FK-FK, MK-BK, or WK-WK.*

**Table 3 - Component Dynamic Capacity**

 Dia. x Lead	 Flanged Nut $C_{am}$ (kN)	 Cylindrical Nut $C_{am}$ (kN)	 Threaded Nut $C_{am}$ (kN)	 BK Support $C_{am}$ (kN)	 FK / MK Support $C_{am}$ (kN)	 WK Support $C_{am}$ (kN)
12 x 5	-	4.4	-	1.9	1.9	-
16 x 5	9.3	9.3	12.1	2.1	2.1	-
16 x 10	15.4	15.4	-	2.1	2.1	-
20 x 5	10.5	10.5	14.8	2.4	2.4	-
25 x 5	12.3	12.3	20.4	4.2	10.2	26.6
25 x 10	13.2	13.2	19.9	4.2	10.2	26.6
25 x 20	13.0	13.0	-	4.2	10.2	26.6
25 x 25	16.7	16.7	-	4.2	10.2	26.6
25 x 50	15.4	15.4	-	4.2	10.2	26.6
32 x 5	21.5	21.5	23.3	7.0	12.3	40.5
32 x 10	33.4	33.4	-	7.0	12.3	40.5
32 x 20	29.7	29.7	-	7.0	12.3	40.5
32 x 32	18.0	-	-	7.0	12.3	40.5
32 X 40	14.9	14.9	-	7.0	12.3	40.5
40 x 5	23.8	23.8	26.3	9.2	16.1	43.0
40 x 10	38.0	38.0	78.6	9.2	16.1	43.0
40 x 20	33.3	33.3	-	9.2	16.1	43.0
40 x 40	35.0	35.0	-	9.2	16.1	43.0
50 x 10	68.7	68.7	97.8	18.0	-	52.0
50 x 20	60.0	60.0	-	18.0	-	52.0

**Step 4 - Verify screw meets critical speed limitation**

- Acceptable length / speed combinations are below and left of the selected curve (screw diameter)

**Figure 1 - Critical Speed Graph**

**Speed vs Length (Metric Series)  
BF-FF, MK-BF, FK-BK**

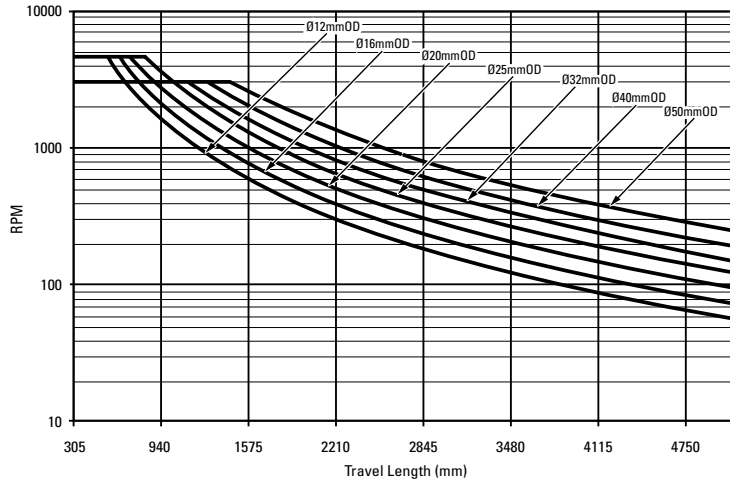

**Speed vs Length (Metric Series)  
BK-BK, FK-FK, MK-BK, WK-WK**

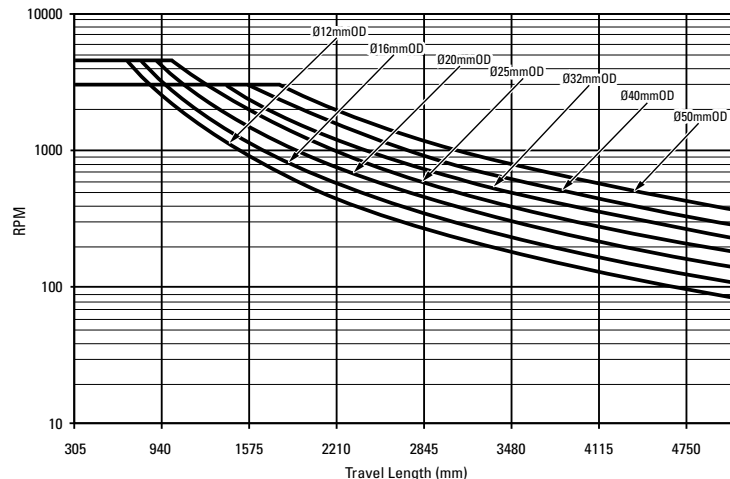

**Step 5 - Build Quick-Install Engineered Ball Screw Part Number - Metric Series Example**

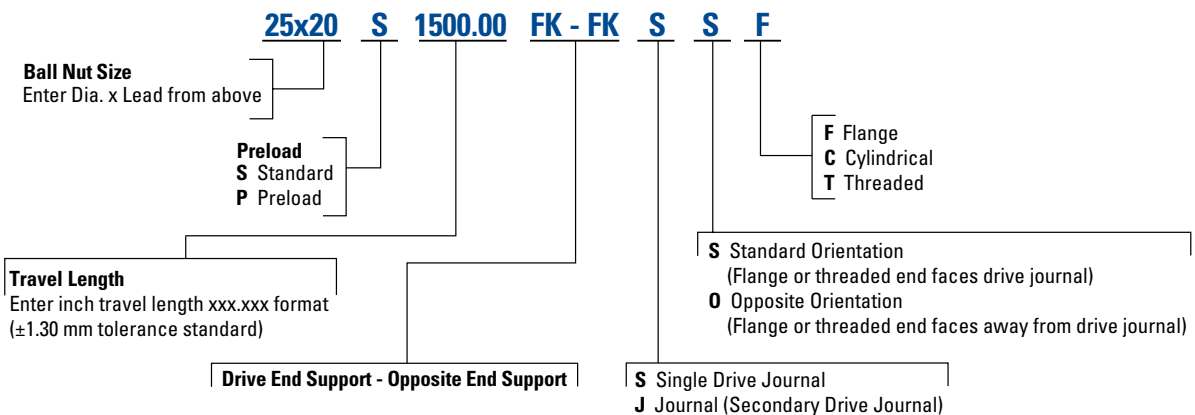





**Step 6 - Contact Thomson Customer Support (Call 540-633-3549) or thomson@thomsonlinear.com or your local Thomson Distributor to order**







# How to Install a Ball Screw Assembly

## Step 1 - Determine Extended Ball Nut Length







- Determine the overall length of the ball nut including accessories
- Extended Ball Nut Length = Ball Nut Length + Flange Adder + Wiper Adder

 Dia x Lead	 Standard Nut P/N	Standard Ball Nut Length (in)	 Preload Nut P/N	Preload Ball Nut Length (in)	 Flange Adder (in)	 Wiper Adder (in)
.500 x .200	8105-448-013	2.750	8105-448-008	5.950	0.150	0.287
.500 x .500	8105-448-014	1.750	-	-	0.150	0.287
.631 x .200	8106-448-022	1.710	8106-448-012	3.875	0.030	-
.631 x 1.000	7826713	1.710	7827531	3.440	0.030	0.287
.750 x .200	8107-448-018	1.880	8107-448-025	4.080	0.030	0.306
.750 x .500	8107-448-014	2.930	8107-448-011	6.180	0.030	0.306
.875 x .200	5708277	2.704	-	-	0.020	0.242
1.000 x .250	8110-448-055	2.347	5704167	4.847	0.030	- / 0.344
1.000 x .500	8110-448-022	3.120	8110-448-016	6.640	0.005	0.306
1.000 x 1.000	8110-448-086	3.000	-	-	0.030	-
1.150 x .200	8111-448-006	2.500	8111-448-004	5.500	0.015	0.306
1.500 x .250	7833233	2.875	7833234	6.375	0.020	0.287
1.500 x .473	5707513	4.312	-	-	0.020	0.287
1.500 x .500	8115-448-016	5.565	8115-448-006	12.100	0.030	-
1.500 x 1.000	5708280	3.628	5700698	7.628	0.020	0.328
1.500 x 1.875	5707654	5.000	5704272	10.625	0.020	0.328
1.500 x 2.000	8115-448-056	5.250	-	-	0.020	-
2.000 x .500	8120-448-011	6.380	8120-448-006	13.920	0.031	-
2.000 x 1.000	8120-448-021	6.380	8120-448-019	13.900	0.031	-

 Dia x Lead	 Flanged Nut P/N	Ball Nut Length (in)	 Cylindrical Nut P/N	Ball Nut Length (in)	 Threaded Nut P/N	Ball Nut Length (in)
12 x 5	-	-	KGM-N-1205-RH-00	0.945	-	-
16 x 5	KGF-D-1605-RH-EE	1.654	KGM-D-1605-RH-EE	1.339	7832778	2.264
16 x 10	KGF-D-1610-RH-EE	2.165	KGM-D-1610-RH-EE	1.969	-	-
20 x 5	KGF-D-2005-RH-EE	1.654	KGM-D-2005-RH-EE	1.339	7832781	2.264
25 x 5	KGF-D-2505-RH-EE	1.654	KGM-D-2505-RH-EE	1.339	7832788	2.500
25 x 10	KGF-D-2510-RH-EE	2.165	KGM-D-2510-RH-EE	1.772	7832792	2.402
25 x 20	KGF-D-2520-RH-EE	1.378	KGM-D-2520-RH-EE	1.378	-	-
25 x 25	KGF-D-2525-RH-EE	1.378	KGM-D-2525-RH-EE	1.378	-	-
25 x 50	KGF-D-2550-RH-EE	2.283	KGM-D-2550-RH-EE	2.283	-	-
32 x 5	KGF-D-3205-RH-EE	2.165	KGM-D-3205-RH-EE	1.772	7832797	2.579
32 x 10	KGF-D-3210-RH-EE	2.717	KGM-N-3210-RH-EE	2.362	-	-
32 x 20	KGF-D-3220-RH-EE	3.150	KGM-N-3220-RH-EE	2.756	-	-
32 x 32	KGF-D-3232-RH-EE	1.654	-	-	-	-
32 X 40	KGF-N-3240-RH-EE	1.772	KGM-N-3240-RH-EE	1.772	-	-
40 x 5	KGF-D-4005-RH-EE	2.244	KGM-D-4005-RH-EE	1.772	7832806	2.657
40 x 10	KGF-D-4010-RH-EE	2.795	KGM-D-4010-RH-EE	2.362	7832810	4.154
40 x 20	KGF-D-4020-RH-EE	3.150	KGM-D-4020-RH-EE	2.756	-	-
40 x 40	KGF-D-4040-RH-EE	3.346	KGM-D-4040-RH-EE	3.346	-	-
50 x 10	KGF-D-5010-RH-EE	3.740	KGM-N-5010-RH-EE	3.228	7832819	4.646
50 x 20	KGF-D-5020-RH-EE	3.740	KGM-N-5020-RH-EE	3.228	-	-

## Step 2 - Determine Screw Length

- Determine overall length of ball screw (OAL)
- OAL = Travel + Extended Ball Nut Length + End Support Configuration (Table Below)

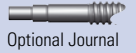
Ball Nut Dia	 BK - BK	 BK - BF	 FK - FK	 FK - FF	 MK - BK	 MK - BF	 WK - WK	 Optional Journal BK/FK/MK, BF/FF, WK
0.500 in / 12mm	3.425	2.658	3.425	2.500	3.425	2.658	-	0.591 / 0.591 / -
0.631 in / 16mm	3.425	2.677	3.425	2.579	3.425	2.677	-	0.591 / 0.591 / -
0.750 in / 20mm	3.937	3.091	4.488	3.307	4.213	3.367	-	0.787 / 0.787 / -
0.875 in	5.079	3.839	5.472	3.976	-	-	7.717	0.905 / 0.905 / 1.339
1.000 in / 25mm	5.158	3.977	5.866	4.291	5.512	4.331	7.717	0.984 / 0.866 / 1.339
1.150 in / 32mm	6.299	4.822	7.165	5.137	6.732	5.255	8.543	1.181 / 1.181 / 1.535
1.500 x .473 & 1.000 in	6.299	4.822	7.165	5.137	6.732	5.255	8.543	1.181 / 1.181 / 1.535
1.500 x .200, .250, .500 in	7.166	5.473	7.166	5.375	7.166	5.473	8.819	1.496 / 1.496 / 1.811
1.500 x 1.875 & 2.000 in / 40mm	7.166	5.473	7.166	5.375	7.166	5.473	8.819	1.496 / 1.496 / 1.811
2.000 in / 50mm	9.291	6.910	-	-	-	-	9.409	1.969 / 1.969 / 2.165



### Step 3 - Determine Mounting Pattern

- Table below indicates mounting interface ("A" = Travel Length + Nut Length)

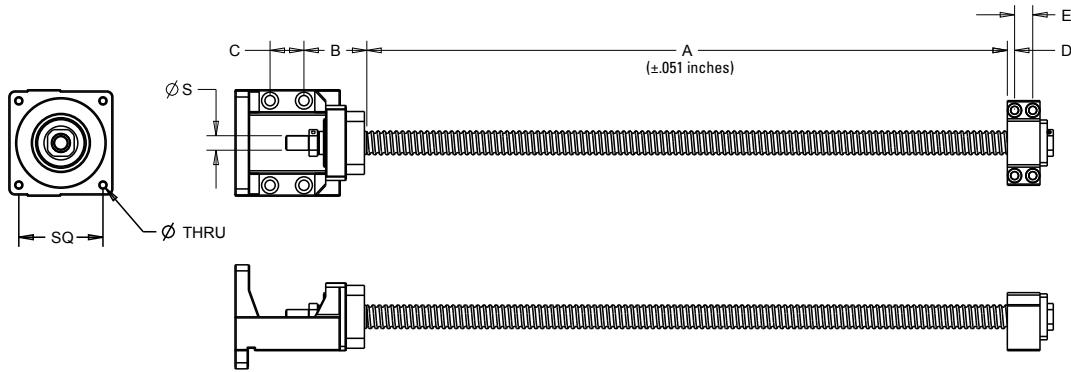

Ball Nut Dia	BK - BK	BK - BF	MK - BK	MK - BF	MK			ALL
					Motor Interface	Mounting Pattern "SQ" (in)	"THRU" Hole	Drive Shaft "S" (in)
0.500 in / 12mm	.256 / .512 / .256 / .512	.256 / .512 / .394 / -	1.339 / .787 / .256 / .512	1.339 / .787 / .394 / -	NEMA 23	1.856	M4 x .7	.3150 / .3144
0.631 in / 16mm	.256 / .512 / .256 / .512	.256 / .512 / .394 / -	1.339 / .787 / .256 / .512	1.339 / .787 / .394 / -	NEMA 23	1.856	M4 x .7	.3937 / .3931
0.750 in 20mm	.236 / .591 / .236 / .591	.236 / .591 / .394 / -	1.536 / 1.102 / .236 / .591	1.536 / 1.102 / .394 / -	NEMA 23	1.856	M4 x .7	.4724 / .4717
0.875 in	.315 / .748 / .315 / .748	.315 / .748 / .453 / -	-	-	-	-	-	.5906 / .5898
1.000 in / 25mm	.315 / .748 / .315 / .748	.315 / .748 / .512 / -	2.008 / 1.654 / .315 / .748	2.008 / 1.654 / .512 / -	NEMA 34	2.740	M6 x 1.0	.6693 / .6686
1.150 in / 32mm	.394 / .866 / .394 / .866	.394 / .866 / .591 / -	-	-	-	-	-	.7874 / .7866
1.500 x .473 & 1.000 in	.394 / .866 / .394 / .866	.394 / .866 / .591 / -	-	-	-	-	-	.7874 / .7866
1.500 x .200, .250, .500 in	.433 / .906 / .433 / .906	.433 / .906 / .630 / -	-	-	-	-	-	.9843 / .9834
1.500 x 1.875 & 2.000 in / 40mm	.433 / .906 / .433 / .906	.433 / .906 / .630 / -	-	-	-	-	-	.9843 / .9834
2.000 in / 50mm	.551 / 1.299 / .551 / 1.299	.551 / 1.299 / .728 / -	-	-	-	-	-	1.3780 / 1.3771

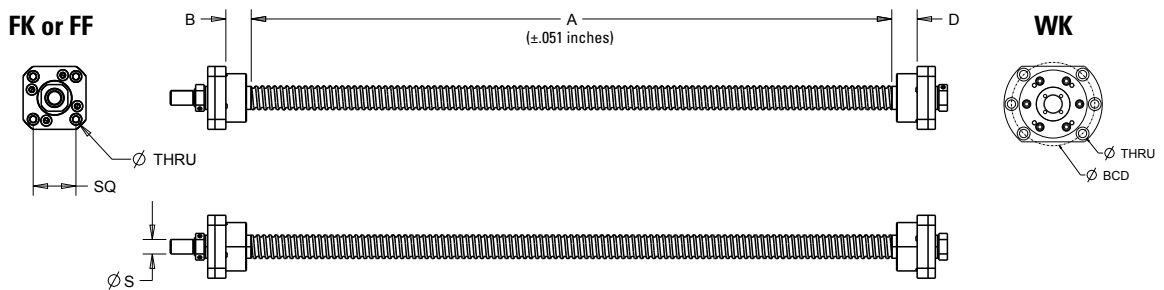

Ball Nut Dia	FK - FK	FK - FF	FK / FF		WK - WK			ALL
			Mounting Pattern "SQ" (in)	"THRU" Hole Clearance & C' bore for given screw		Mounting Pattern "BCD" (in)	"THRU" Hole (in) Clearance & C' bore for given screw	Drive Shaft "S" (in)
0.500 in / 12mm	0.689 / .689	.669 / .196	1.170 / 0.974	M4 / M3	-	-	-	.3150 / .3144
0.631 in / 16mm	0.689 / .689	.669 / .315	1.225 / 1.170	M4 / M4	-	-	-	.3937 / .3931
0.750 in 20mm	0.827 / .827	.827 / .315	1.392 / 1.392	M5 / M5	-	-	-	.4724 / .4717
0.875 in	0.945 / .945	.945 / .354	1.726 / 1.726	M6 / M6	1.260 / 1.260	3.465	M8	.5906 / .5898
1.000 in / 25mm	1.220 / 1.220	1.220 / .354	1.949 / 1.949	M6 / M6	1.260 / 1.260	3.465	M8	.6693 / .6686
1.150 in / 32mm	1.378 / 1.378	1.378 / .394	2.228 / 2.228	M8 / M8	1.300 / 1.300	4.331	M10	.7874 / .7866
1.500 x .473 & 1.000 in	1.378 / 1.378	1.378 / .394	2.228 / 2.228	M8 / M8	1.300 / 1.300	4.331	M10	.7874 / .7866
1.500 x .200, .250, .500 in	1.142 / 1.142	1.142 / .354	2.645 / 2.645	M10 / M10	1.300 / 1.300	4.331	M10	.9843 / .9834
1.500 x 1.875 & 2.000 in / 40mm	1.142 / 1.142	1.142 / .354	2.645 / 2.645	M10 / M10	1.300 / 1.300	4.331	M10	.9843 / .9834
2.000 in / 50mm	-	-	-	-	1.300 / 1.300	4.764	M10	1.3780 / 1.3771



## Did you know...

- Ball screw selection needs to be based on load rating of the ball screw AND the end supports. The end supports are typically the limiting component in regards to axial capacity.
- Ball screws are case hardened to a minimum of 56 HRC and typically above 60 HRC. Machining of the ends requires specialized tooling and processes to save tool life, and prevent excessive run-out and poor surface finishes.
- Ball screw components are typically shipped with only a rust preventative coating. Improper lubrication of ball screws can reduce life by 90%.
- Improper transfer of the ball nut unto the screw can result in trapped balls that can destroy a ball screw in minutes.
- Improper transfer of the ball nut unto the screw can result in lost balls that can reduce the life of the assembly.
- Improper installation of bearing supports may damage seals and angular contact bearings of the end supports causing rough operation and premature failure.
- Poor system alignment is among the leading causes of ball screw failure.

## Thomson advantages and benefits...

- Engineered systems to meet demanding applications.
- Full spectrum of tools to help select the correct product.
- Experienced assemblers trained to correctly build ball screw systems.
- Quality components that will perform and last.
- Plug-and-play assemblies ready to be installed in your machine.

## Bearing Supports/End Machining Product Overview

**Thomson Bearing Supports** — complete package for simple mounting of Thomson ball screw assemblies. Flange and Base mounts available with dual angular contact bearings or floating radial bearing.

- Rugged steel construction
- Low profile, compact design
- Base or Flange mounting configurations
- Pre-assembled and ready for installation
- Available off-the-shelf

### BK Bearing Support<sup>(1)</sup>

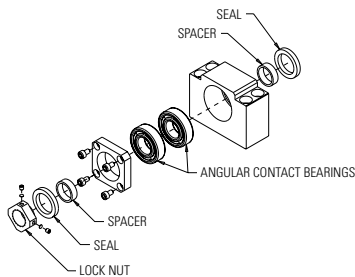

The base mounted BK Bearing Support contains an angular contact bearing pair for increased stiffness and axial load capacity. Design dimensions fit standard Type BK or BK1 end machining.

### FK Bearing Support<sup>(1)</sup>

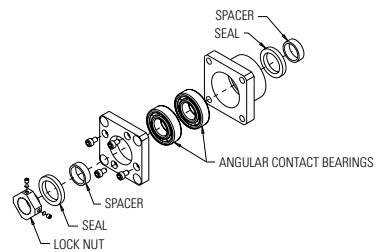

The flange mounted FK Bearing Support contains an angular contact bearing pair for increased stiffness and axial load capacity. Design dimensions fit standard Type FK or FK1 end machining.

### BF Bearing Support<sup>(2)</sup>

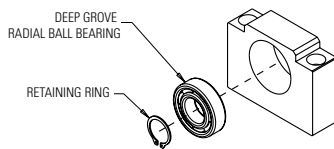

The base mounted BF Bearing Support contains a floating radial bearing to allow axial shaft movement. Design dimensions fit standard Type BF or BF1 end machining.

### FF Bearing Support<sup>(2)</sup>

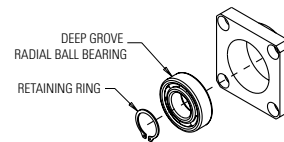

The flange mounted FF Bearing Support contains a floating radial bearing to allow axial shaft movement. Design dimensions fit standard Type FF or FF1 end machining.

### MK Bearing Support<sup>(1)</sup>

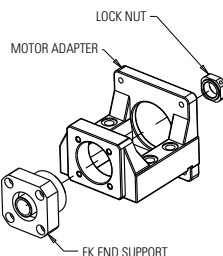

Base mounted NEMA 23 or 34 motor mount. Design dimensions fit standard Type FK end machining.

### WK Bearing Support<sup>(1)</sup>

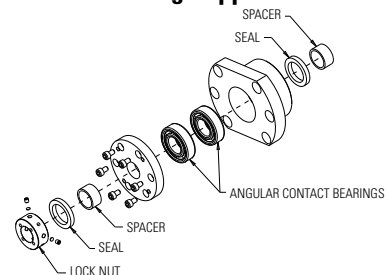

Heavy duty flange mounted WK support contains higher load capacity bearings. Design dimensions fit standard WK or WK1 end machining.

(1) Locknut included in assembly

(2) Retaining ring included in assembly

## USA, CANADA and MEXICO

Thomson  
203A West Rock Road  
Radford, VA 24141, USA  
Phone: 1-540-633-3549  
Fax: 1-540-633-0294  
E-mail: [thomson@thomsonlinear.com](mailto:thomson@thomsonlinear.com)  
Literature: [literature.thomsonlinear.com](http://literature.thomsonlinear.com)

## EUROPE

### United Kingdom

Thomson  
Phone: +44 (0) 1271 334 500  
Fax: +44 (0) 1271 334 501  
E-mail: [sales.uk@thomsonlinear.com](mailto:sales.uk@thomsonlinear.com)

### Germany

Thomson  
Nürtinger Straße 70  
72649 Wolfschlugen  
Phone: +49 (0) 7022 504 0  
Fax: +49 (0) 7022 504 405  
E-mail: [sales.germany@thomsonlinear.com](mailto:sales.germany@thomsonlinear.com)

### France

Thomson  
Phone: +33 (0) 243 50 03 30  
Fax: +33 (0) 243 50 03 39  
E-mail: [sales.france@thomsonlinear.com](mailto:sales.france@thomsonlinear.com)

### Italy

Thomson  
Largo Brughetti  
20030 Bovisio Masciago  
Phone: +39 0362 594260  
Fax: +39 0362 594263  
E-mail: [info@thomsonlinear.it](mailto:info@thomsonlinear.it)

### Spain

Thomson  
Rbla Badal, 29-31 7th, 1st  
08014 Barcelona  
Phone: +34 (0) 9329 80278  
Fax: + 34 (0) 9329 80278  
E-mail: [sales.esm@thomsonlinear.com](mailto:sales.esm@thomsonlinear.com)

### Sweden

Thomson  
Estridsväg 10  
29109 Kristianstad  
Phone: +46 (0) 44 24 67 00  
Fax: +46 (0) 44 24 40 85  
E-mail: [sales.scandinavia@thomsonlinear.com](mailto:sales.scandinavia@thomsonlinear.com)

## ASIA

### Asia Pacific

Thomson  
750, Oasis, Chai Chee Road,  
#03-20, Technopark @ Chai Chee,  
Singapore 469000  
E-mail: [sales.hk@thomsonlinear.com](mailto:sales.hk@thomsonlinear.com)

### China

Thomson  
Rm 2205, Scitech Tower  
22 Jianguomen Wai Street  
Beijing 100004  
Phone: +86 400 6661 802  
Fax: +86 10 6515 0263  
E-mail: [sales.china@thomsonlinear.com](mailto:sales.china@thomsonlinear.com)

### India

Thomson India  
1001, Sigma Building  
Hiranandani Business Park  
Powai, Mumbai – 400076  
Phone: +91 22 422 70 300  
Fax: +91 22 422 70 338  
E-mail: [sales.india@thomsonlinear.com](mailto:sales.india@thomsonlinear.com)

### Japan

Thomson  
Minami-Kaneden 2-12-23, Suita  
Osaka 564-0044  
Phone: +81-6-6386-8001  
Fax: +81-6-6386-5022  
E-mail: [csinfo\\_dicgj@danaher.co.jp](mailto:csinfo_dicgj@danaher.co.jp)

### Korea

Thomson  
F12 Ilsong Bldg, 157-37  
Samsung-dong, Kangnam-gu  
Seoul (135-090)  
Phone: +82 2 6917 5049  
Fax: +82 2 6917 5007  
E-mail: [sales.korea@thomsonlinear.com](mailto:sales.korea@thomsonlinear.com)

201202-01 TPS 3x 03/2013 USA  
Specifications are subject to change without notice. It is the responsibility of the product user to determine  
the suitability of this product for a specific application. All trademarks property of their respective owners.  
© 2013 Thomson Industries, Inc.