

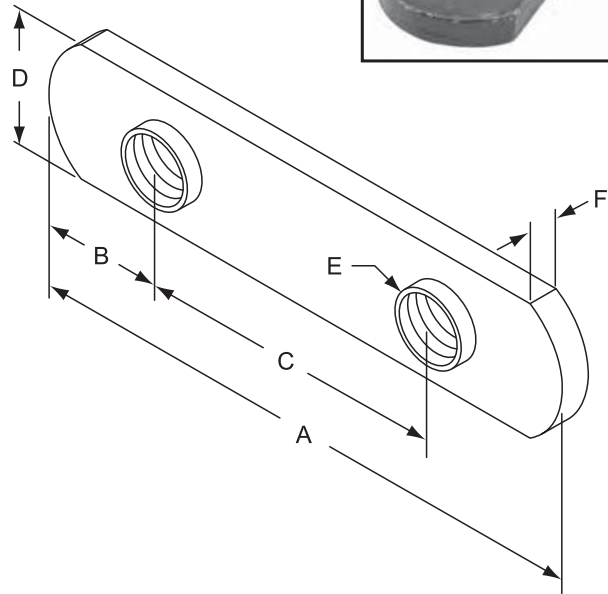

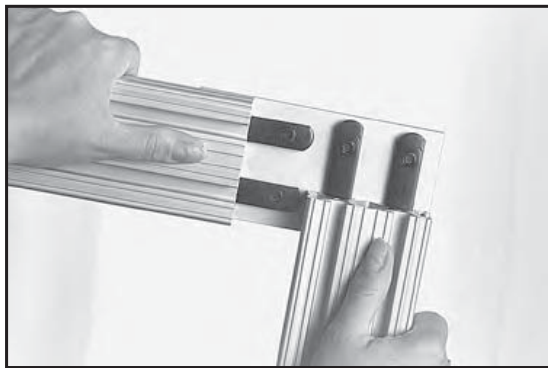
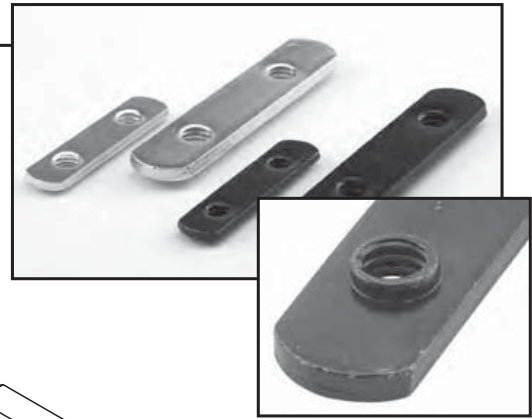

# Fractional

## Double Slide-In Economy T-Nuts

- Reduces assembly time
- Loads from the profile end only
- Perfect for multiple hole joining plates
- Made from steel with bright and black zinc finishes
- Refer to pages 249-259 for our full screw and bolt offering



Part No.	A	B	C	D	E (Thread)	F	Finish	Lbs.
3281 	1.375	.187	1.000	.443	8-32	.095	Black Zinc	.019
3280 	1.875	.443	1.000	.443	1/4-20	.095	Black Zinc	.012
3800 	1.870	.443	1.000	.443	M6 x 1.00	.095	Bright Zinc	.012
3279	2.810	.655	1.500	.625	5/16-18	.142	Black Zinc	.063
3879	3.000	.750	1.500	.625	M8 x 1.25	.142	Bright Zinc	.063

 = 10 Series Compatible Part

### Threaded Pilot Projection

The threaded pilot projection provides more thread, adding strength to the fastener. Always position the projection down in the T-slot to avoid crashing and an uneven connection.

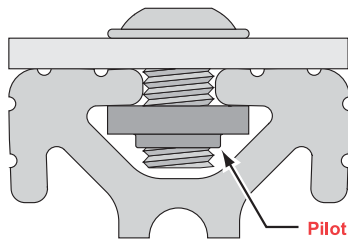

Pilot Projection  
Should Always  
Face Down

